

# H

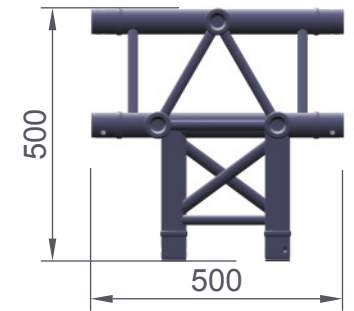
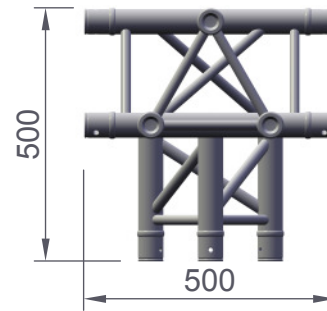
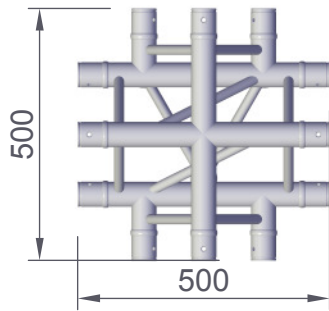

<b>HOF KON</b>		290-3		C52
Art.no.	112290352	TÜV		HOF Alutec GmbH & Co. KG
	Tube	50x2 mm	EUROCODE 9	
	Bracing	20x2 mm		
	EN-AW 6082T6			
	Weight	6,5 kg		