

# H

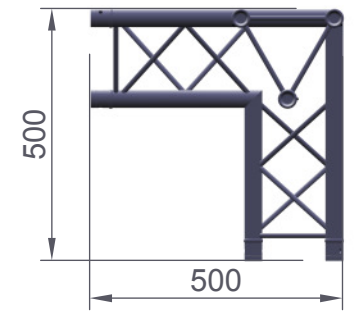
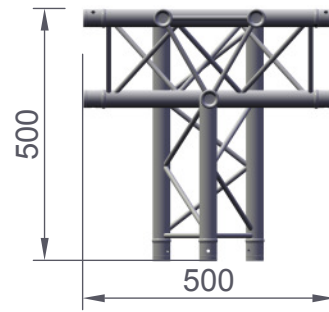
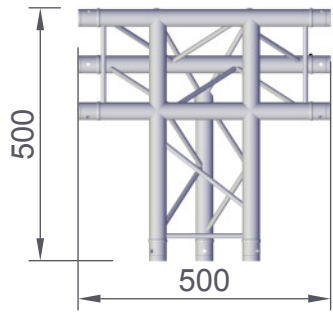

<b>HOF KON</b>		220-3		C42
Art.no.	118220342	TÜV		HOF Alutec GmbH & Co. KG
	Tube	35x2 mm	EUROCODE 9	
	Bracing	10x2 mm		
	EN-AW 6060T66			
	Weight	3,1 kg		