

H

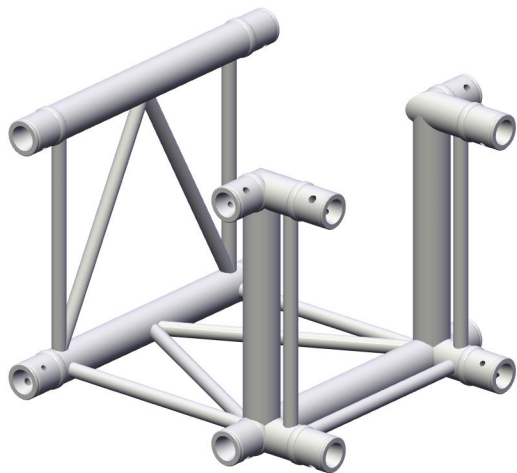
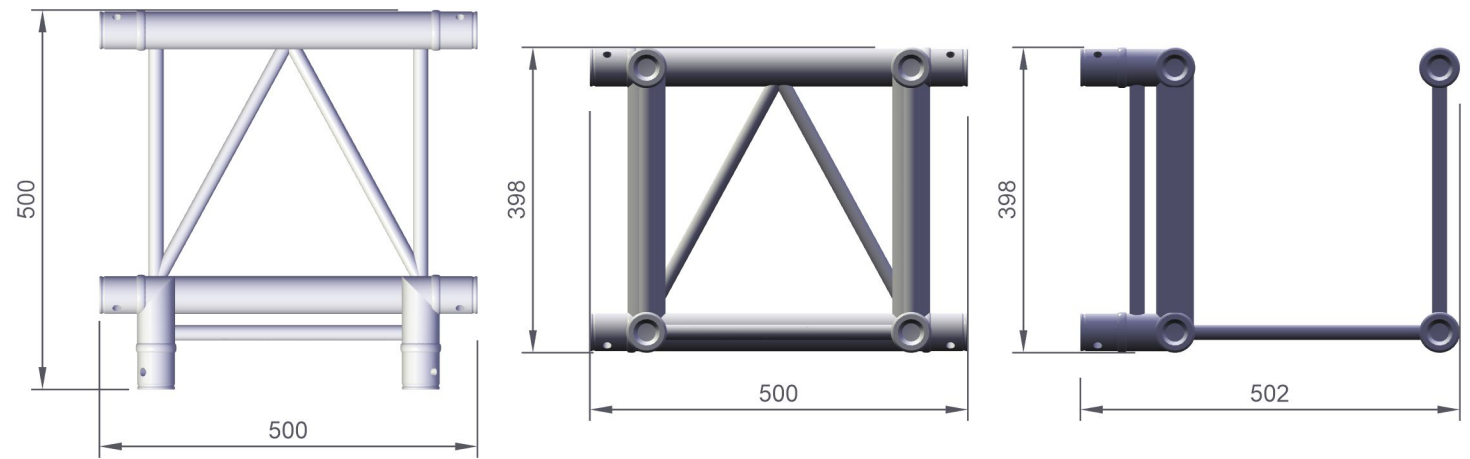

H^{OF} KON		400-i		C35
Art.no.	122400435	TÜV		H.O.F. Alutec GmbH & Co. KG
	Tube	50x2 mm	EUROCODE 9	
	Bracing	25x2 mm		
	EN-AW 6082T6			
	Weight	6,02 kg		