

H

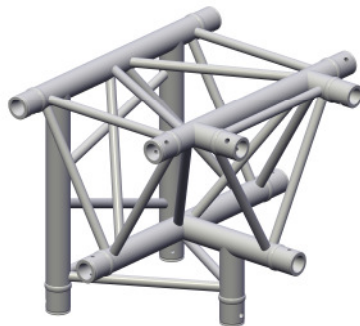
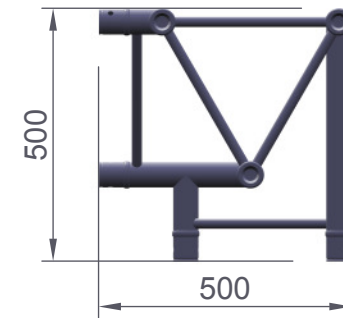
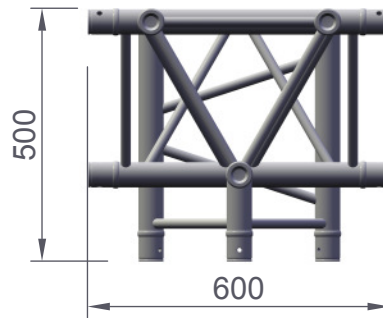
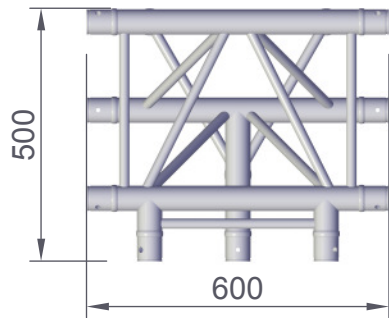

HOF KON		400-3		C42
Art.no.	112400342	TÜV		HOF Alutec GmbH & Co. KG
	Tube	50x2 mm	EUROCODE 9	
	Bracing	25x2 mm		
	EN-AW 6082T6			
	Weight	7,5 kg		